

APPROVAL SHEET

MODEL NO.: _____ SMD2920 Series _____

CUSTOMER:

CUSTOMER'S APPROVAL:

AUTHORIZED SIGNATURE/STAMP

DATE

MANUFACTURER:

The Fourth Industrial Zone, Luokeng Village, Xiaotie District, Xiaojinkou Town, Huizhou City, Guangdong Province, China

Tel: 0752-7213069/7213070

Fax: 0752-7213065

Submitted by:

Approved by:

Date:

Performance Specification

Model	Marking	V _{max} (V dc)	I _{max} (A)	I _{hold} @25°C (A)	I _{trip} @25°C (A)	P _d Typ. (W)	Maximum Time To Trip		Resistance	
							Current (A)	Time (Sec)	R _{i min} (Ω)	R _{1max} (Ω)
SMD2920R030SF	R030	60	10	0.30	0.60	1.5	1.5	3.0	0.600	4.800
SMD2920R030SF72V	R030	72	10	0.30	0.60	1.5	1.5	3.0	0.600	4.800
SMD2920R050SF	R050	60	10	0.50	1.00	1.5	2.5	4.0	0.180	1.400
SMD2920R075SF	R075	33	40	0.75	1.50	1.5	8.0	0.3	0.100	1.000
SMD2920R075SF60V	R075	60	40	0.75	1.50	1.5	8.0	0.3	0.100	1.000
SMD2920R100SF	R100	33	40	1.10	2.20	1.5	8.0	0.5	0.065	0.410
SMD2920R100SF60V	R100	60	40	1.10	2.20	1.5	8.0	0.5	0.065	0.410
SMD2920R125SF	R125	33	40	1.25	2.50	1.5	8.0	2.0	0.050	0.250
SMD2920R150SF	R150	33	40	1.50	3.00	1.5	8.0	2.0	0.035	0.230
SMD2920R150SF42V	R150	42	40	1.50	3.00	1.5	8.0	2.0	0.035	0.230
SMD2920R185SF	R185	33	40	1.85	3.70	1.5	8.0	2.5	0.030	0.150
SMD2920R185SF42V	R185	42	40	1.85	3.70	1.5	8.0	2.5	0.030	0.150
SMD2920R200SF	R200	16	40	2.00	4.00	1.5	8.0	4.5	0.020	0.120
SMD2920R200SF24V	R200	24	40	2.00	4.00	1.5	8.0	4.5	0.020	0.120
SMD2920R200SF33V	R200	33	40	2.00	4.00	1.5	8.0	4.5	0.020	0.120
SMD2920R200SF42V	R200	42	40	2.00	4.00	1.5	8.0	4.5	0.020	0.120
SMD2920R250SF	R250	16	40	2.50	5.00	1.5	8.0	16.0	0.020	0.085
SMD2920R250SF24V	R250	24	40	2.50	5.00	1.5	8.0	16.0	0.020	0.085
SMD2920R250SF33V	R250	33	40	2.50	5.00	1.5	8.0	16.0	0.020	0.085
SMD2920R260SF	R260	6	40	2.60	5.20	1.5	8.0	10.0	0.014	0.075
SMD2920R260SF16V	R260	16	40	2.60	5.20	1.5	8.0	10.0	0.014	0.075
SMD2920R260SF24V	R260	24	40	2.60	5.20	1.5	8.0	10.0	0.014	0.075
SMD2920R300SF	R300	6	40	3.00	6.00	1.5	8.0	20.0	0.012	0.048
SMD2920R300SF16V	R300	16	40	3.00	6.00	1.5	8.0	20.0	0.012	0.048
SMD2920R300SF24V	R300	24	40	3.00	6.00	1.5	8.0	20.0	0.012	0.048
SMD2920R300SF30V	R300	30	40	3.00	6.00	1.5	8.0	20.0	0.012	0.048
SMD2920R300SF33V	R300	33	40	3.00	6.00	1.5	8.0	20.0	0.012	0.048
SMD2920R400SF	R400	6	40	4.00	8.00	1.5	20.0	4.0	0.006	0.030
SMD2920R400SF16V	R400	16	40	4.00	8.00	1.5	20.0	4.0	0.006	0.030
SMD2920R400SF24V	R400	24	40	4.00	8.00	1.5	20.0	4.0	0.006	0.030
SMD2920R500SF	R500	6	40	5.00	10.00	1.5	25.0	5.0	0.005	0.025
SMD2920R500SF12V	R500	12	40	5.00	10.00	1.5	25.0	5.0	0.005	0.025
SMD2920R500SF16V	R500	16	40	5.00	10.00	1.5	25.0	5.0	0.005	0.025
SMD2920R500SF24V	R500	24	40	5.00	10.00	1.5	25.0	5.0	0.005	0.025
SMD2920R600SF	R600	6	40	6.00	12.00	1.5	25.0	6.0	0.004	0.020
SMD2920R600SF12V	R600	12	40	6.00	12.00	1.5	25.0	6.0	0.004	0.020
SMD2920R600SF16V	R600	16	40	6.00	12.00	1.5	25.0	6.0	0.004	0.020
SMD2920R700SF	R700	6	40	7.00	14.00	1.5	25.0	6.0	0.0025	0.010
SMD2920R700SF12V	R700	12	40	7.00	14.00	1.5	25.0	6.0	0.0025	0.010

V_{max} = Maximum operating voltage device can withstand without damage at rated current (I_{max}).

HuiZhou DaRong Electronic Technology CO.,LTD



SMD2920 HF Series Surface Mount PTC Devices

- I max = Maximum fault current device can withstand without damage at rated voltage (V max).
- I hold = Hold Current. Maximum current device will not trip in 25°C still air.
- I trip = Trip Current. Minimum current at which the device will always trip in 25°C still air.
- Pd = Power dissipation when device is in the tripped state in 25°C still air environment at rated voltage.
- Ri min/max = Minimum/Maximum device resistance prior to tripping at 25°C.
- R1max = Maximum device resistance is measured one hour post reflow.
- CAUTION : Operation beyond the specified ratings may result in damage and possible arcing and flame.

Environmental Specifications

Test	Conditions	Resistance change
Passive aging	+85°C, 1000 hrs.	I HOLD/I TRIP PASS
Humidity aging	+85°C, 85% R.H. , 168 hours	I HOLD/I TRIP PASS
Thermal shock	+85°C to -40°C, 20 times	I HOLD/I TRIP PASS
Resistance to solvent	MIL-STD-202,Method 215	No change
Vibration	MIL-STD-202,Method 201	No change
Ambient operating conditions : - 40 °C to +85 °C		
Maximum surface temperature of the device in the tripped state is 125 °C		

Agency Approval and Environmental Compliance

Agency	File Number	Regulation	Standard
UL	pending		2002/95/EC
TUV	pending		EN14582

Thermal Derating Chart

Recommended Hold Current(A) at Ambient Temperature(°C)

Model	Ambient Operation Temperature								
	-40°C	-20°C	0°C	25°C	40°C	50°C	60°C	70°C	85°C
SMD2920R030SF	0.45	0.40	0.35	0.30	0.25	0.23	0.20	0.17	0.14
SMD2920R050SF	0.76	0.67	0.59	0.50	0.42	0.38	0.33	0.29	0.23
SMD2920R075SF	1.13	1.01	0.88	0.75	0.62	0.56	0.50	0.44	0.34
SMD2920R100SF	1.66	1.47	1.29	1.10	0.91	0.83	0.73	0.64	0.50
SMD2920R125SF	1.89	1.68	1.46	1.25	1.04	0.94	0.83	0.73	0.56
SMD2920R150SF	2.27	2.01	1.76	1.50	1.25	1.13	1.00	0.87	0.74
SMD2920R185SF	2.80	2.47	2.17	1.85	1.54	1.39	1.22	1.07	0.85
SMD2920R200SF	3.02	2.68	2.34	2.00	1.66	1.50	1.32	1.16	0.90
SMD2920R250SF	3.78	3.35	2.93	2.50	2.08	1.88	1.65	1.45	1.13
SMD2920R260SF	3.64	3.25	2.91	2.60	2.26	2.08	1.95	1.74	1.13
SMD2920R300SF	4.53	4.02	3.51	3.00	2.52	2.26	1.99	1.75	1.34
SMD2920R400SF	6.04	5.36	4.68	4.00	3.36	3.01	2.65	2.33	1.79
SMD2920R500SF	7.55	6.70	5.85	5.00	4.20	3.77	3.32	2.92	2.23
SMD2920R600SF	8.60	7.70	6.80	6.00	4.95	4.60	4.06	3.65	3.15
SMD2920R700SF	10.03	8.98	7.93	7.00	5.77	5.36	4.73	4.26	3.68

Thermal Derating Curve

Average Time-Current Curve

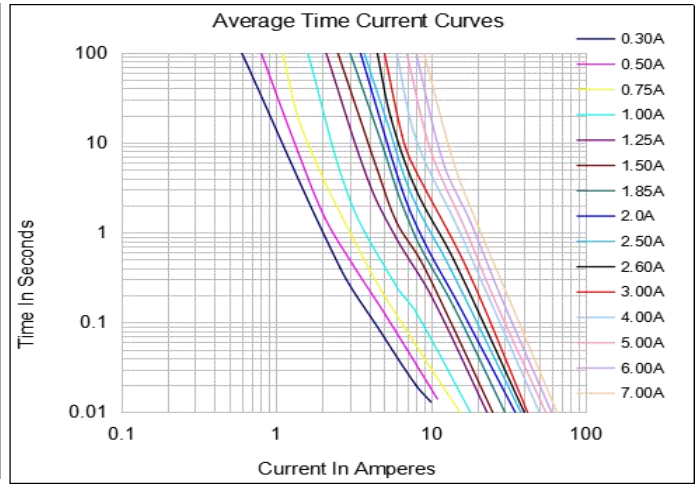
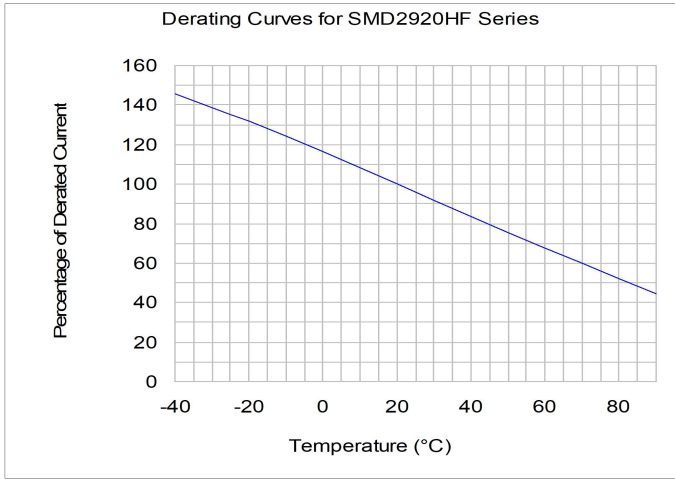

Soldering Parameters

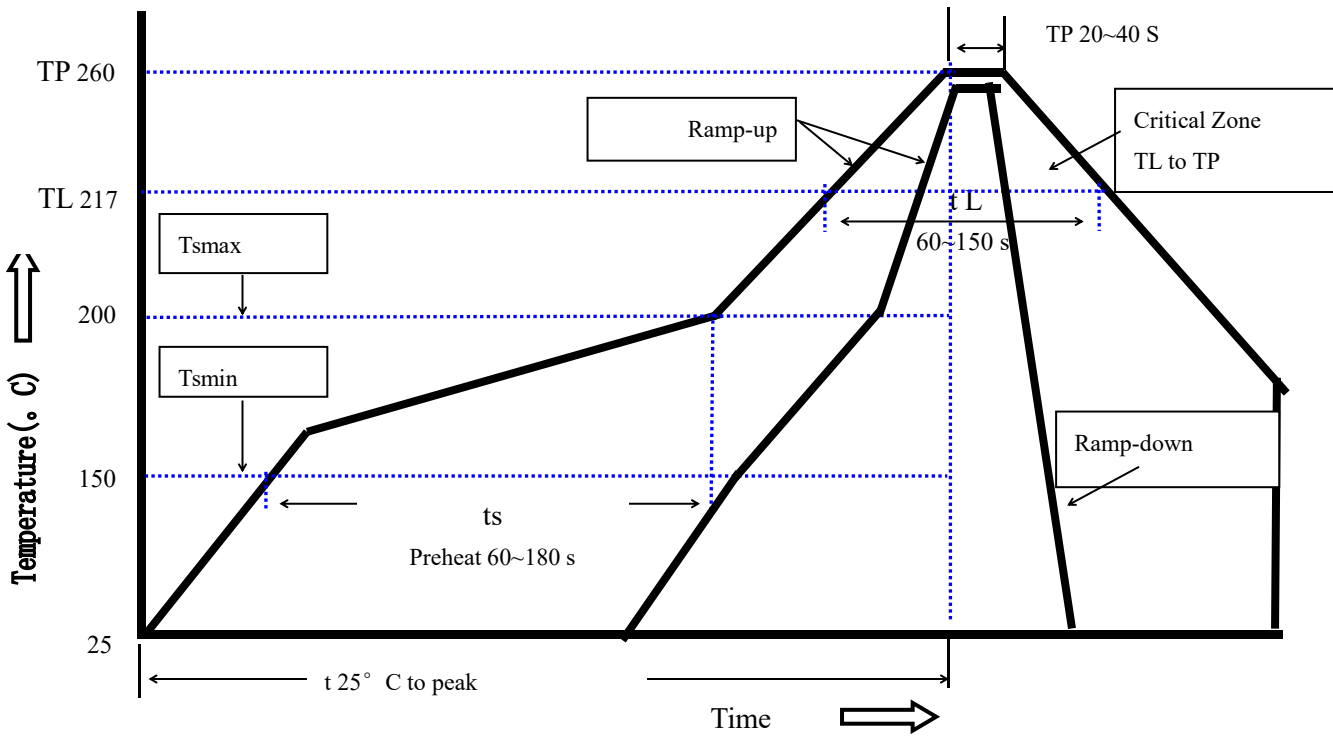

Profile Feature	Pb-Free Assembly
Average Ramp-Up Rate(Ts max to T p)	3°C/second mac.
Preheat	
-Temperature Min(Ts min)	150°C
-Temperature Max(Ts max)	200°C
-Time(Ts min to Ts max)	60~180 seconds
Time maintained above:	
-Temperature(TL)	217°C
-Time(tL)	60~150 seconds
Peak Temperature(Tp)	260°C

R HuiZhou DaRong Electronic Technology CO.,LTD
SMD2920 HF Series Surface Mount PTC Devices

Ramp-Down Rate	6°C/second max.
Time 25°C to Peak Temperature	8 minutes max
Storage Condition	0°C~30°C,30%~60%RH

Recommended reflow methods: IR, vapor phase oven, hot air oven, N2 environment for lead-free

Recommended maximum paste thickness is 0.25mm

Devices can be cleaned using standard industry methods and solvents.

Note 1: All temperature refer to topside of the package, measured on the package body surface.

Note 2: If reflow temperatures exceed the recommended profile, devices may not meet the performance requirements.

Physical Dimensions(mm.)

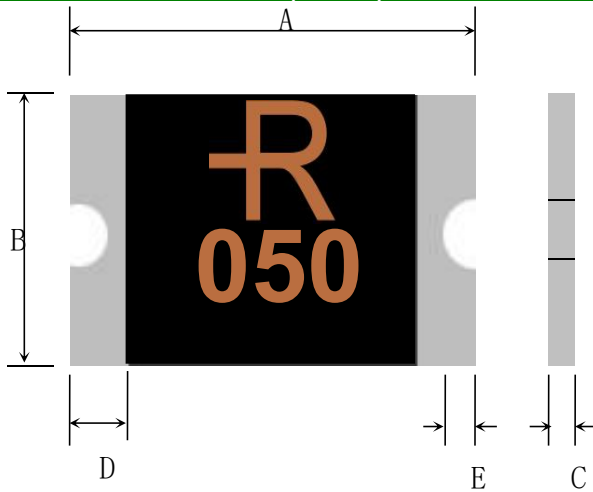

Model	A		B		C		D	E
	Min.	Max.	Min.	Max.	Min.	Max.	Min.	Min.
SMD2920R030SF	6.73	7.98	4.80	5.44	0.60	1.20	0.30	0.25
SMD2920R030SF72V	6.73	7.98	4.80	5.44	0.60	1.20	0.30	0.25
SMD2920R050SF	6.73	7.98	4.80	5.44	0.80	1.60	0.30	0.25
SMD2920R075SF	6.73	7.98	4.80	5.44	0.70	1.30	0.30	0.25
SMD2920R075SF60V	6.73	7.98	4.80	5.44	0.80	1.60	0.30	0.25
SMD2920R100SF	6.73	7.98	4.80	5.44	0.40	1.00	0.30	0.25
SMD2920R100SF60V	6.73	7.98	4.80	5.44	1.00	2.10	0.30	0.25
SMD2920R125SF	6.73	7.98	4.80	5.44	0.40	1.00	0.30	0.25
SMD2920R150SF	6.73	7.98	4.80	5.44	0.50	1.30	0.30	0.25
SMD2920R150SF42V	6.73	7.98	4.80	5.44	0.50	1.30	0.30	0.25
SMD2920R185SF	6.73	7.98	4.80	5.44	0.70	1.40	0.30	0.25
SMD2920R185SF42V	6.73	7.98	4.80	5.44	0.70	1.40	0.30	0.25
SMD2920R200SF	6.73	7.98	4.80	5.44	0.70	1.40	0.30	0.25
SMD2920R200SF24V	6.73	7.98	4.80	5.44	0.70	1.40	0.30	0.25
SMD2920R200SF33V	6.73	7.98	4.80	5.44	0.70	1.40	0.30	0.25
SMD2920R200SF42V	6.73	7.98	4.80	5.44	0.70	1.40	0.30	0.25
SMD2920R250SF	6.73	7.98	4.80	5.44	0.7	1.40	0.30	0.25

HuiZhou DaRong Electronic Technology CO.,LTD
SMD2920 HF Series Surface Mount PTC Devices

SMD2920R250SF24V	6.73	7.98	4.80	5.44	0.7	1.40	0.30	0.25
SMD2920R250SF33V	6.73	7.98	4.80	5.44	0.7	1.40	0.30	0.25
SMD2920R260SF	6.73	7.98	4.80	5.44	0.7	1.40	0.30	0.25
SMD2920R260SF16V	6.73	7.98	4.80	5.44	0.70	1.40	0.30	0.25
SMD2920R260SF24V	6.73	7.98	4.80	5.44	0.70	1.40	0.30	0.25
SMD2920R300SF	6.73	7.98	4.80	5.44	0.60	1.20	0.30	0.25
SMD2920R300SF16V	6.73	7.98	4.80	5.44	0.60	1.20	0.30	0.25
SMD2920R300SF24V	6.73	7.98	4.80	5.44	0.60	1.20	0.30	0.25
SMD2920R300SF30V	6.73	7.98	4.80	5.44	0.60	1.20	0.30	0.25
SMD2920R300SF33V	6.73	7.98	4.80	5.44	0.60	1.20	0.30	0.25
SMD2920R400SF	6.73	7.98	4.80	5.44	0.80	1.60	0.30	0.25
SMD2920R400SF16V	6.73	7.98	4.80	5.44	0.80	1.60	0.30	0.25
SMD2920R400SF24V	6.73	7.98	4.80	5.44	0.80	1.60	0.30	0.25
SMD2920R500SF	6.73	7.98	4.80	5.44	0.80	1.60	0.30	0.25
SMD2920R500SF12V	6.73	7.98	4.80	5.44	0.80	1.60	0.30	0.25
SMD2920R500SF16V	6.73	7.98	4.80	5.44	0.80	1.60	0.30	0.25
SMD2920R500SF24V	6.73	7.98	4.80	5.44	0.80	1.60	0.30	0.25
SMD2920R600SF	6.73	7.98	4.80	5.44	0.80	1.60	0.30	0.25
SMD2920R600SF12V	6.73	7.98	4.80	5.44	0.80	1.60	0.30	0.25
SMD2920R600SF16V	6.73	7.98	4.80	5.44	0.80	1.60	0.30	0.25
SMD2920R700SF	6.73	7.98	4.80	5.44	0.80	1.60	0.30	0.25
SMD2920R700SF12V	6.73	7.98	4.80	5.44	0.80	1.60	0.30	0.25

Termination Pad Characteristics

Terminal pad materials: Tin-plated Nickel-Copper

Terminal pad solder ability: Meets EIA specification RS186-9E and ANSI/J-STD-002 Category 3.

Recommended Pad Layout (mm.)

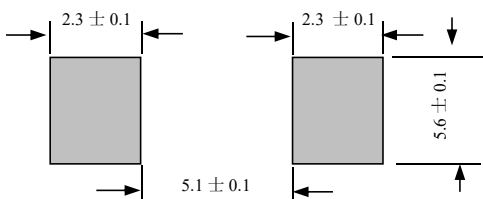

注：在此印锡面积条件下，推荐钢网厚度为 ≥ 0.12 MM(钢网厚度不够要增大刷锡面积)

Packaging Quantity

Part Number	Quantity
SMD2920 Series	1500 pcs/reel
SMD2920R100SF60V	1000 pcs/reel

Tape & reel packaging per EIA481-1

Tape And Reel Specifications (mm)

Governing Specifications		EIA 481-2
W	16.00 ± 0.3	
P0	4.00 ± 0.10	
P1	8.00 ± 0.10	
P2	2.00 ± 0.05	
A0	5.70 ± 0.10	
B0	8.00 ± 0.10	
B1max.	12.10	
D0	1.50 + 0.1, -0	
F	7.50 ± 0.05	
E1	1.75 ± 0.10	
E2min.	14.25	
T	0.60	
T1max.	0.10	
K0	0.80 ± 0.1	
Leader min.	390	
Trailer min.	160	
Reel Dimensions		
A max.	178	
N min.	60	
W1	16.40 ± 0.5	
W2	22.40	

EIA Tape Component Dimensions

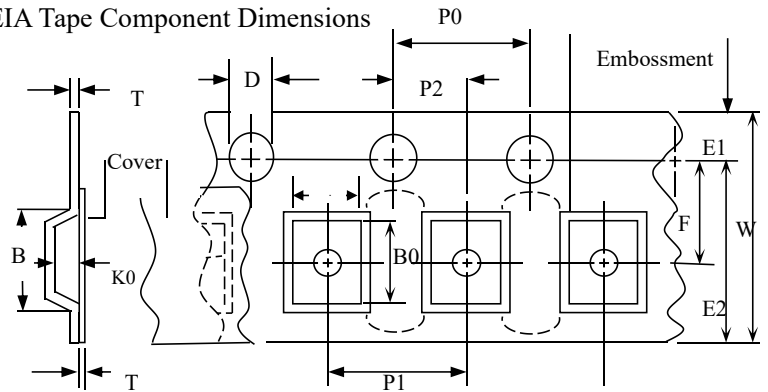

EIA Reel Dimensions

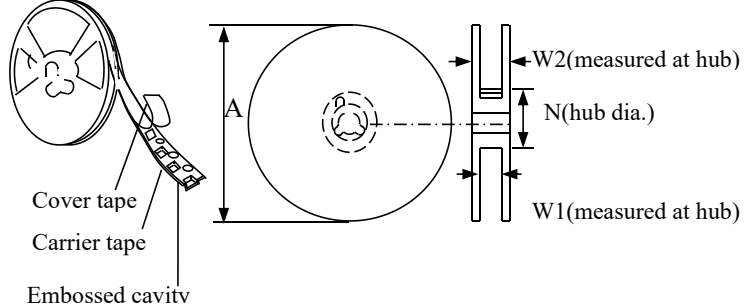

Storage And Handling

- Storage conditions: 0°C-30°C , 30%~60% R.H.
- Devices may not meet specified performance if storage conditions are exceeded.

Part Number System

SMD 2920 R □□□ S F □□ V

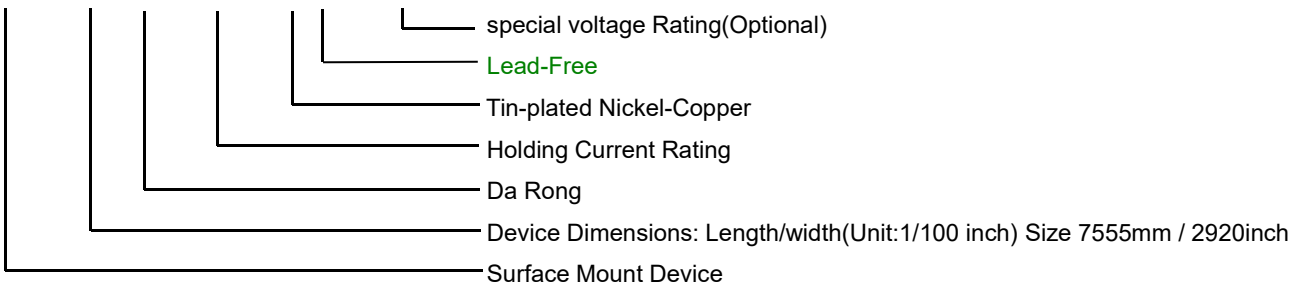

注意事项

PPTC 使用注意事项:

- PPTC 为热敏元件，对环境温度比较敏感，建议在 PPTC 周围不要设计热源元件，尽量减少外部热源的影响。
 - 请在规格书规定的参数下 (<10%) 使用，超出电压电流规格值，会导致 PPTC 出现电弧，阻值升高，甚至烧片。
 - 规格书的电气特性，均是基于在大容指定测试板经过一次回流焊之后的测试；如果客户有二次回流焊或者注塑点胶等其他热工序，会对上述参数有一定程度的衰减，需要验证其适用性。
 - PPTC 贴片产品是为 SMT 工艺设计的封装形式，焊接工艺为回流焊；要求客户遵守我们推荐的焊盘布局和回流焊配置文件。不正确的电路板布局或回流配置可能会对 PPTC 的可焊性性能产生负面影响。焊接工艺可参考大容推荐的回流焊曲线。如果回流焊温度超过推荐的值，PPTC 将有可能受到损伤。使用手工焊及波峰焊接 PPTC 可能会导致产品焊后电阻超出规格。
 - 某些注塑料、单组份、双组份固化胶粘剂、硅胶、侵蚀性溶剂污染 PPTC 材料破坏芯片，需要对注塑料胶料等材料牌号以及应用参数（如温度、时间等）进行验证，以确保产品及工艺的匹配性，确认不会影响 PPTC 性能之后方可使用。
- PPTC 在充电线端应用中，建议使用 PP 类材料做内膜，禁止使用 TPE 类与 PVC 类等材料做内膜。
- PPTC 贴装或使用过程中，不建议使用洗板水或其他清洗剂进行清洗。如必须使用，需要验证各类清洗剂、洗板水以及溶剂的适用性，确认不会影响 PPTC 性能之后方可使用。已知对 PPTC 有影响的化学药品包括但不限于醚类、苯类、酮类以及脂类等较强溶解性、破坏性的有机化合物，清洗后将产品放置于敞开的环境中至少 24 小时，将残留的溶剂进行充分的挥发。
 - 装配过程中，避免用暴力砸、挤、压、拉、扭、刺等方式作用 PPTC 本体，以免引起 PPTC 性能衰减。
 - PPTC 元件是为电路中偶尔出现的过流而设计的，不建议用在连续且持续过流的电路中。
 - 大容 SMD PPTC 湿敏等级为 2 级，为密封包装。客户如在库存中发现有包装破损的，立即将产品隔离处理；使用时如有余料，需恢复之前包装状态，做密封保存，否则会影响产品性能导致焊后电阻越规格。
 - 产品废弃时，可按照一般电子废弃物处理，具体材料组成可参见 MSDS